

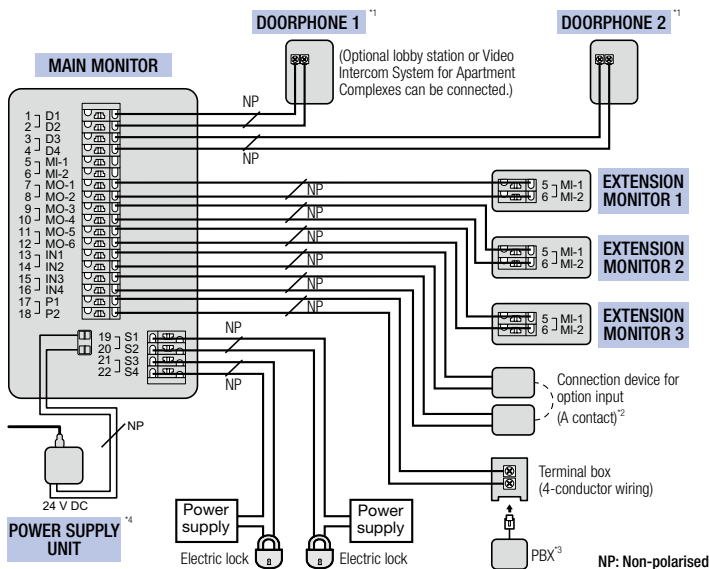

Key Features

- **Highly Expandable:** Up to 3 7-inch wide monitors can be connected to the main monitor. In addition, PBX connectivity is also supported.
- **7-inch Screen:** The main monitor and extension monitor have a 7-inch wide screen that offers easy viewing of wide vertical and horizontal views.
- **Voice Change Function:** This function makes woman's voice (higher keys) sounds like a man's (lower keys).
- **Electric Lock Release Support for Gate:**
The gate or door lock can be easily and quickly released using monitors.
- **Picture Recording Function:**
The main monitor and extension monitor can record doorphone images from up to 50 doorphone calls or monitoring sessions. (up to 8 still images per visitor/session)
- **Night Vision with LED lights (illumination lamp):**
Door station is equipped with LED lights (illumination lamp). It enables the colour display of visitors at a distance of about 50 cm at night.

Wiring Schematic Diagram



Wire type and length

Wiring run	Wire type ⁵		
	Diameter		Length (Max.)
Doorphone –	φ 0.65 mm	22 AWG	100 m
Main monitor –	φ 1.0 mm	18 AWG	130 m
Extension monitor ⁶	φ 0.5 mm	CAT 5	50 m
Main monitor –	φ 0.65 mm	22 AWG	10 m
Power supply unit	φ 1.0 mm	18 AWG	20 m
Main monitor – Electric lock ⁷	φ 0.5 mm - φ 1.2 mm	(24 AWG - 17 AWG)	According to the specification of connected device.
Main monitor – Connection device for option input (A contact) ⁷	φ 0.5 mm - φ 1.2 mm	(24 AWG - 17 AWG)	According to the specification of connected device.
Main monitor – PBX	φ 0.65 mm	CAT 3 or 22 AWG	100 m

⁵Type: Single-pair cable with outer sheath (jacket)

Conductor: Copper solid

• A certified power supply wiring has to be used with this equipment. The relevant national installation and/or equipment regulations shall be considered. A certified power supply wiring not lighter than ordinary polyvinyl chloride flexible wiring according to IEC 60227 shall be used.

⁶When an extension monitor is used, make sure that the total wiring length from the doorphone to the main monitor and then to the extension monitor, is within about 100 m.

⁷When using an electric lock or a connection device for option input (A contact), select a device that meets the following guidelines:

- Electric lock connection terminal (S1/S2, S3/S4):
 - N/O dry closure contact
 - 30 V AC (1 A)/24 V DC (1 A) or lower
- Connection device for option input (A contact) terminal (IN1/IN2/IN3/IN4):
 - Input method: No-voltage contact
 - Open-circuit voltage between terminals: DC 7 V or less
 - Detection definite time: 0.1 seconds or more
 - Short-circuit between terminals: 5 mA or less
 - Resistance value: make: 500 Ω or less, break: 15 KΩ or more

¹ When you use an additional doorphone, the maximum number of the electric locks that can be connected to the doorphone depends on the type of doorphone. Consult your dealer for further information.

For VL-V554 users:

- Make sure to only connect electric door locks to the S1/S2 terminals of the doorphones.

² Connection devices for option input (A contact) can be used when a VL-V900 and VL-V700 series Video Intercom System for Apartment Complexes is used.

- Make sure to connect emergency terminals to the IN1/IN2 terminals.

- Make sure to connect doorbells to the IN3/IN4 terminals. A doorbell and doorphone 2 cannot be used together.

³ Connectable PBX Model Numbers: KX-TDA30/100/100D/200/600 series, KX-TDE100/200/600 series, KX-NS300/500/700/1000 series

Please consult your dealer when connecting with a PBX.

⁴ VL-SV72/VL-MV72 only

Optional Accessories

Door Station (Doorphone)

VL-V522L (Surface mount)



Door Station (Doorphone)

CMOS 1.0 M pixels
VL-V554 (Surface mount)
VL-V554U (Flash mount)
CMOS 0.3 M pixels
VL-V555 (Surface mount)



Extension Monitor

VL-MV71
VL-MV72

(Power source)

VL-MV71: 220-240 V AC, 50/60 Hz

VL-MV72: 24 V DC Power supply unit (supplied)



Lobby Station

Up to 20 main monitors can be connected.



Model Composition

VL-SV71	VL-MV71 x 1, VL-V522L x 1
VL-SV72	VL-MV72 x 1, VL-V522L x 1, VL-PS241 x 1

Specifications

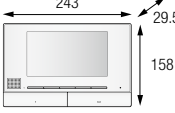
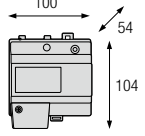
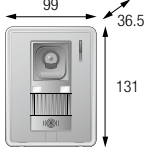
Model number and name	VL-MV71 VL-MV72	VL-PS241 (VL-MV72 only)	VL-V522L
	Main Monitor Station (Main monitor) Extension Monitor	Power supply unit	Door Station (Doorphone)
Dimensions (mm)	Up to 3 (not including the main monitor) 		Up to 2 
Power source	VL-MV71: 220-240 V AC, 50/60 Hz VL-MV72: Power supply unit (VL-PS241) 24 V DC, 0.4 A	Input: 220-240 V AC, 0.2 A, 50/60 Hz Output: 24 V DC, 0.6 A	Power supplied by the main monitor
Power consumption	VL-MV71: Standby: Approx. 2.0 W During operation: Approx. 10.5 W VL-MV72: Standby: Approx. 1.6 W During operation: Approx. 9.8 W	-	-
Dimensions (H x W x D) (Excluding protruding sections)	158 x 243 x 29.5 mm	104 x 100 x 54 mm	131 x 99 x 36.5 mm
Weight	VL-MV71: 835g VL-MV72: 710g	215 g	200 g
Operating environment	Ambient temperature: Approx. 0 °C to +40 °C Relative humidity (non-condensing): up to 90 %	Ambient temperature: Approx. 0 °C to +50 °C Relative humidity (non-condensing): up to 90 %	Ambient temperature: Approx. -15 °C to +55 °C Relative humidity (non-condensing): up to 90 % (tested up to -20 °C)
Display	7-inch wide colour / WVGA (800 x 480 pixels)	-	-
Display language	English, Arabic	-	-
Talking method	Hands-free	-	-
Viewing angle	-	-	Horizontally: Approx. 87° Vertically: Approx. 66°
Installation method	Wall mount (mounting bracket supplied)	Wall mount or attach to DIN rail	Surface mount (mounting base supplied)
Minimum illuminance required	-	-	1 lx (within approx. 50 cm from the camera lens)
Lighting method	-	-	Warm white coloured LED lights, Infrared LEDs
Transmitting range	-	-	-
IP rating / IK rating	-	-	IPX3
External material	Flame retardant PC+ABS resin, Flame retardant ABS resin	Flame retardant PC+ABS resin	Flame retardant ABS resin

* Water resistance is only assured if the doorphone is installed correctly according to the instructions in the Installation Guide, and appropriate water protection measures are taken.

Installing the Doorphone

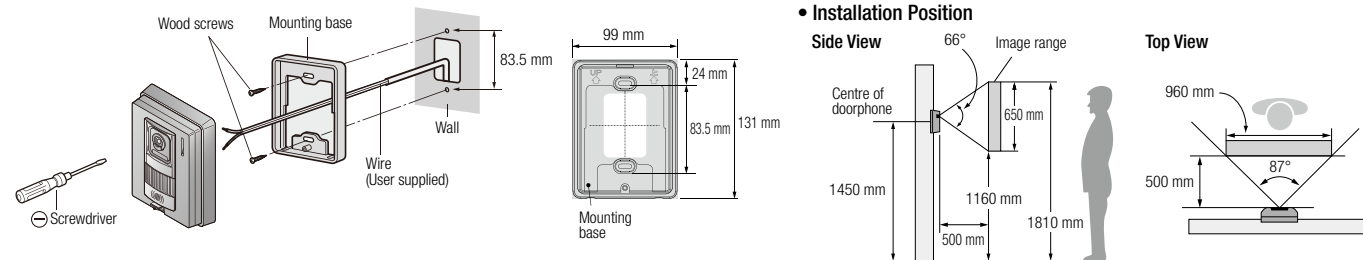

Installing the Main Monitor/Extension Monitor

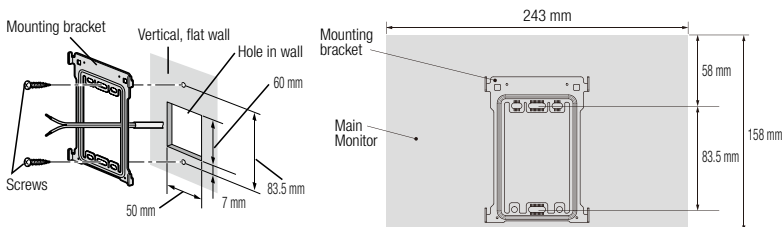

Installing the Power Supply Unit

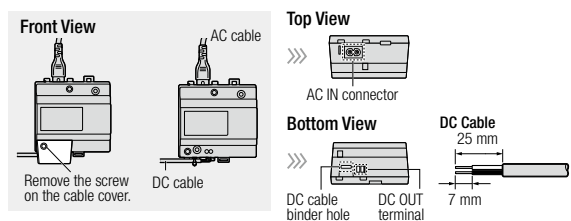

Important

- Safety Precaution: carefully read the operating instructions and installation manual before using this product.

- The actual product may vary slightly from photograph.
- Weights and dimensions are approximate.
- Design and Specifications are subject to change without notice.
- These products may be subject to export control regulations.

DISTRIBUTED BY :

Panasonic[®]